

DynaRound Safety Gate Installation Instructions

Estimated Installation Time: 2 Person Crew, 20 – 30 minutes

INSTALLATION INSTRUCTIONS ARE FOR:

- PN 505240.1/505242.1 DynaRound Safety Gate Kit 24" (610 mm) Opening**
- PN 505300.1/505302.1 DynaRound Safety Gate Kit 30" (762 mm) Opening**
- PN 505360.1/505362.1 DynaRound Safety Gate Kit 36" (914 mm) Opening**

FOR INSTALLATION TO:

- 1.9" (48 mm) OD FRP or Steel Round Tube Posts**
- 1.5" x 1.5" (38 mm x 38 mm) min. to 2.5" x 2.5" (63.5 mm x 63.5 mm) FRP Square Tube Posts**
- 1.5" x 1.5" (38 mm x 38 mm) min. Steel Angle Posts (max. thickness 5/8" or 15.9 mm)**
- 1.5" x 1.5" (38 mm x 38 mm) min. to 2.5" x 2.5" (63.5 mm x 63.5 mm) Steel Square Tube Posts**

TOOLS REQUIRED

- Electric/Cordless Drill with #2 Phillips Screwdriver Bit**
- 3/16" (4.8 mm) and 5/32" (4 mm) drill bits if installing in steel posts.**
- 9/16" (14 mm) drill bit**
- #2 Phillips Manual Screwdriver**
- Large Manual Slot Screwdriver**
- Marker or Pencil**
- 25-foot tape measure**
- Blue thread locking compound**

NOTE: Cuts and drilled holes must be sealed to maintain corrosion protection.



IMPORTANT

Read these instructions completely before attempting to install the DynaRound Safety Gate. It is important to understand the installation procedure thoroughly prior to beginning work. It is the installer's responsibility to carefully follow these installation instructions to ensure correct operation of the DynaRound Safety Gate. The installer could be liable for claims that result from improper installation.

INSTALLATION INSTRUCTIONS:

1. Inspect and inventory your DynaRound Safety Gate and compare to the packing list or bill of materials to verify that all materials are available for installation. Contact Fibergrate at 1-800-427-4043 to report any missing or damaged material.
2. The DynaRound Safety Gate is designed to be installed for the opening sizes listed in the product description and to round tube posts of 1.9" (48 mm) OD (either FRP or metallic pipe). DynaRound Safety Gate can also be installed on square tube, angle or flat bar posts. Verify all field dimensions prior to installation.

Installation Instructions

3. If installing the gate onto DynaRound Roof Guard or DynaRound Slimline guardrail, the posts on both sides of the opening must be moved so that the post is on the walking surface side of the guardrail and the horizontal railings are on the opposite side of the posts from the typical installation (see isometric view on page 2 of the gate drawings). This can be accomplished by rotating the PN 793201 Open Crossovers 180° around the posts and sliding the post approximately 4-3/8" (111 mm) toward the walking surface side and re-installing the rails.
4. Locate and verify the orientation of the gate and the direction of opening. The gate may be installed with the hinges on the left hand or right hand and must swing toward the walking surface and away from the fall hazard. Verify that the gate can be installed such that the top of the top rail of the gate is at least 42" (1067 mm) above the walking surface.
5. Install the two black, plastic snap-in round adapters into the square recesses on the open leaf of the hinges and slip the hinges over the post. Hold or temporarily clamp the gate in place in the opening. The non-hinge side of the gate should rest against the guardrail. Do not attempt to tension the hinges of the gate until after the installation is complete.
6. When attaching the gate to square tube or angle posts, the snap-in round adapters are omitted and the hinge fastened directly to the post.
7. Following the instructions provided by Tru-Close and shipped with the gate, fasten the hinges to the post using the screws provided. The screws are self-drilling and will install without separate pilot holes if installing to FRP post. Steel posts may require pilot holes as described in the Tru-Close instructions. The hex head screws install on the face of the hinges and the pan head screws install on the sides of the hinges. Torque the hinge screws only until snug tight.
8. With the gate in the closed position, locate the center of the End Support on the post opposite the hinge by measuring down 1-1/2 inches (38 mm) from the lower surface of the top horizontal rail of the gate and make a mark at the centerline of the post. Drill a 9/16" (14 mm) diameter hole through the non-hinge post at this location. For round and square tube posts, drill through both walls of the post.
9. Attach the End Support using the 1/2" x 4" (12.7 x 101.6 mm) carriage bolt for angle posts up to 5/8" thick and the 1/2" x 6" (12.7 x 152.4 mm) carriage bolt for square tube posts up to 2.5 inches (63.5 mm) or for 1.9" (48 mm) round tube posts. For 1.9" (48 mm) diameter round posts only, sandwich the Saddle Connector between the post and the End Support to fill the gap and make a clean installation. The 'saddle' of the Saddle Connector fits over the post and the socket of the Saddle Connector will fit inside of the End Support. The Saddle Connector does not have to be bonded to the End Support.
10. Complete the connection using the flat washer and galvanized nut provided. Apply thread locking compound to the threads of the carriage bolt and torque the nut only as required to secure the End Support. Do not over-torque. Protect the exposed threads of the carriage bolt using the black vinyl cap.
11. Check the gate swing to verify that it swings freely without binding. The gate should be able to swing a minimum of 90° to leave the opening clear for passage. When the gate is closed, there should be a 1/2" (12.7 mm) gap between the top gate rail and the End Support.
12. Adjust the tension on the hinges following the instructions provided by Tru-Close. Apply equal tension to each hinge. Dial in only enough tension so that the gate reliably returns to the closed position when opened. Excessive tension may cause damage to the hinges or gate.
13. When complete, the installation should be inspected to verify correct gate operation, that the height of the top rail of the gate is 42" (1067 mm) or higher, and that all fasteners are properly installed. The operation of the gate should be verified by cycling the gate open and closed at least five times.
14. After installation, the system can be inspected by the owner or the owner's representative and accepted. A written log of the final inspection and acceptance should be kept by the owner.
15. The installed gate should be inspected annually by a qualified inspector. This inspection should include checking the overall operation of the gate, verify that all fasteners are properly installed, and that there is no damage to any gate components. Any corrective actions required by this inspector must be immediately implemented or the gate system should be clearly tagged as unsafe for use until repairs are implemented. Written logs should be kept of every inspection and any corrective actions documented.

DynaRound Safety Gate End Support

PN 505100 (UV COATED)-YL

PN 505102 (UV COATED)-LG

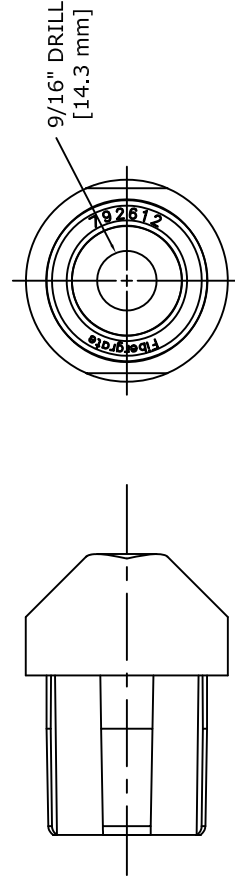
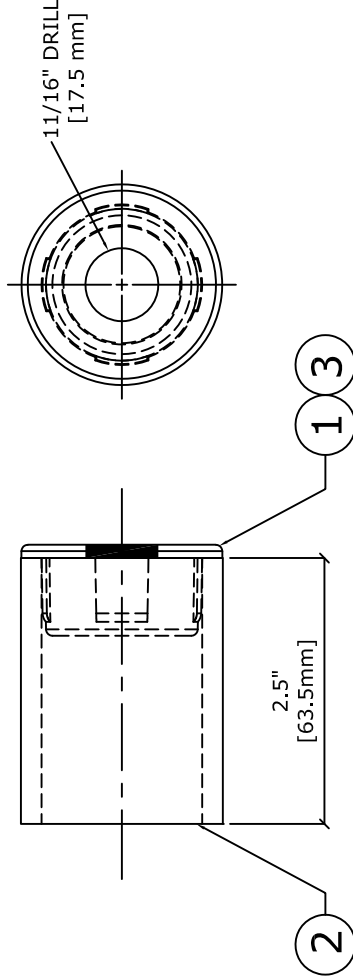

4 1.9" Saddle Connector - Drill and Ship Loose

PN 505100-DynaRound Safety Gate End Support - Yellow UV

ITEM NO.	QTY REQ'D	PART NUMBER	DESCRIPTION
4	1	7926120	1.9" Saddle Connector UV YL
3	1	7926150	End Cap 1.9" OD YL UV
2	0.011	5001010	Round Tube 1.9" x 1.5" ID VF YL UV
1	0.02	007523	Extreme Adhesive

PN 505102-DynaRound Safety Gate End Support - Light Gray UV

ITEM NO.	QTY REQ'D	PART NUMBER	DESCRIPTION
4	1	7926120.1	1.9" Saddle Connector UV LG
3	1	7926152	End Cap 1.9" OD LG UV
2	0.011	5001020	Round Tube 1.9" x 1.5" ID VF LG UV
1	0.02	007523	Extreme Adhesive

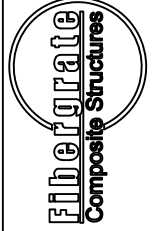

DynaRound

REV	DESCRIPTION	DATE	BY
0	ECN 193	6/21/19	EAL

SCALE	N.T.S.	DATE:	6/7/19
DRAWING NUMBER	50510X		
DRAWN:	EAL		
SHEET	1 OF 1		

WEIGHT = 0.3 lb/0.14 kg

DynaRound Safety Gate 24" Opening

PN 505240 (UV COATED)-YL

PN 505242 (UV COATED)-LG

NOTE: THIS DRAWING IS FOR THE SAFETY GATE ONLY.
SEE PAGES 2 - 3 FOR THE SAFETY GATE KIT.

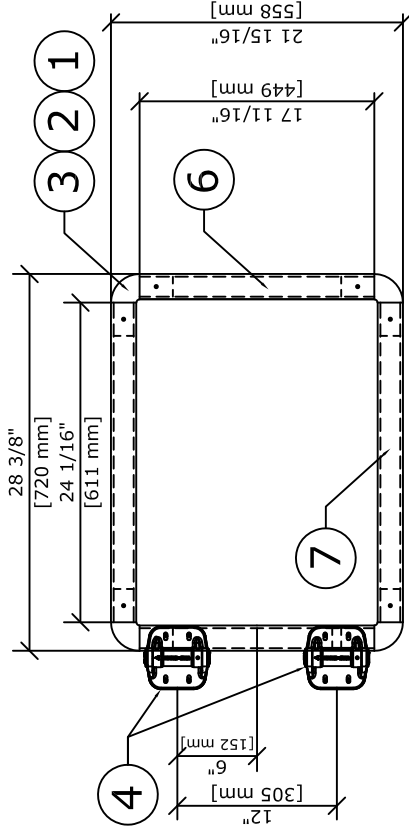
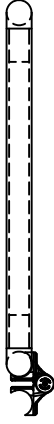

PN 505240-DynaRound Safety Gate-24 inch Opening - Yellow UV

ITEM NO.	QTY REQ'D	PART NUMBER	DESCRIPTION
6 & 7	1	UTILIZE	1.9"Ø Round Tube - YL UV (Parent PN 5001010)
4	1	793115.1	TruClose HD Round Post Hinge (Tru Close PN TCHDRND2-MK2)
3	8	790581	1/8" Dia SS Rivet
2	0.25	007523	Extreme Adhesive
1	4	7926130	90 Deg. Rail Splice YL UV

PN 505242-DynaRound Safety Gate-24 inch Opening - Light Gray UV

ITEM NO.	QTY REQ'D	PART NUMBER	DESCRIPTION
6 & 7	1	UTILIZE	1.9"Ø Round Tube - LG UV (Parent PN 5001012)
4	1	793115.1	TruClose HD Round Post Hinge (Tru Close PN TCHDRND2-MK2)
3	8	790581	1/8" Dia SS Rivet
2	0.25	007523	Extreme Adhesive
1	4	7926132	90 Deg. Rail Splice LG UV

REV	DESCRIPTION	DATE	BY	DynaRound	
0	ECN 189	4/25/19	EAL	SCALE	N.T.S.
1	ECN 193	6/21/19	EAL	DATE:	3/15/19
				DRAWING NUMBER	50524X
				DRAWN:	MFA
				SHEET	1 OF 3

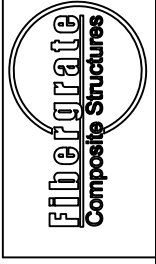

WEIGHT =14.4 lb
(6.3 Kg)

DynaRound Safety Gate Kit 24" Opening

- PN 505240.1 (UV COATED)-YL
- PN 505242.1 (UV COATED)-LG

NOTE: SHIP HINGE INSERTS, HINGE SCREWS, HINGE INSTRUCTIONS AND END SUPPORT COMPONENTS (ALL ITEMS IN DETAIL ON PAGE 3) LOOSE WITH GATE KIT FOR FIELD INSTALLATION.

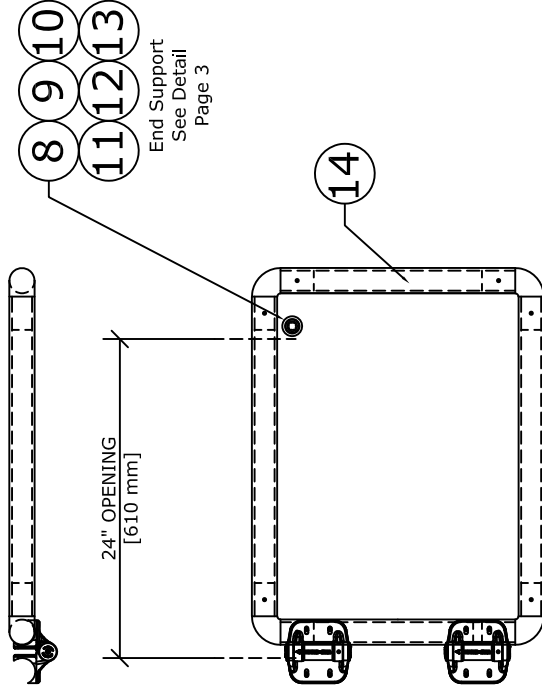

PN 505240.1-DynaRound Safety Gate Kit-24 inch Opening - Yellow UV

ITEM NO.	QTY REQ'D	PART NUMBER	DESCRIPTION
14	1	505240	DynaRound Safety Gate 24" Opening - YL UV
13	1	505100	DynaRound Safety Gate End Support - YL UV
12	1	793115.4	Nut 1/2" Galvanized
11	1	793115.5	Flat Washer 1/2" Galvanized
10	1	793113.1	Caplugs VC-490-8 (Black)
9	1	793115.2	1/2" x 4" Galvanized Carriage Bolt (McM 93604A721)
8	1	793115.3	1/2" x 6" Galvanized Carriage Bolt (McM 93604A729)

REV	DESCRIPTION	DATE	BY
0	ECN 189	4/25/19	EAL
1	ECN 193	6/21/19	EAL

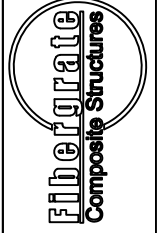

WEIGHT =14.9 lb
(6.8 Kg)

PN 505242.1-DynaRound Safety Gate Kit-24 inch Opening - Light Gray UV

ITEM NO.	QTY REQ'D	PART NUMBER	DESCRIPTION
14	1	505242	DynaRound Safety Gate 24" Opening - LG UV
13	1	505102	DynaRound Safety Gate End Support - LG UV
12	1	793115.4	Nut 1/2" Galvanized
11	1	793115.5	Flat Washer 1/2" Galvanized
10	1	793113.1	Caplugs VC-490-8 (Black)
9	1	793115.2	1/2" x 4" Galvanized Carriage Bolt (McM 93604A721)
8	1	793115.3	1/2" x 6" Galvanized Carriage Bolt (McM 93604A729)

REV	DESCRIPTION	DATE	BY
0	ECN 189	4/25/19	EAL
1	ECN 193	6/21/19	EAL

DynaRound

SCALE: N.T.S. DATE: 3/15/19
DRAWING NUMBER: 50524X
DRAWN: MFA
SHEET: 2 OF 3

DynaRound Safety Gate 30" Opening

PN 505300 (UV COATED)-YL

PN 505302 (UV COATED)-LG

NOTE: THIS DRAWING IS FOR THE SAFETY GATE ONLY.
SEE PAGES 2 - 3 FOR THE SAFETY GATE KIT.

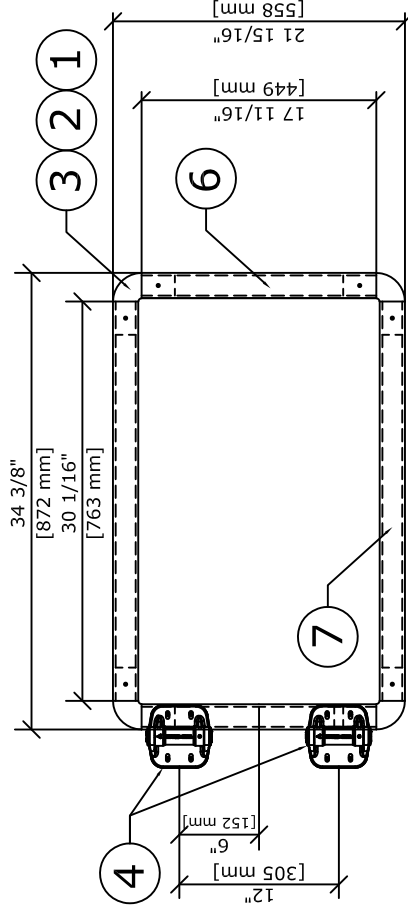

PN 505300-DynaRound Safety Gate-30 inch Opening - Yellow UV

ITEM NO.	QTY REQ'D	PART NUMBER	DESCRIPTION
6 & 7	1	UTILIZE	1.9"Ø Round Tube - YL UV (Parent PN 5001010)
4	1	793115.1	TruClose HD Round Post Hinge (Tru Close PN TCHDRND2-MK2)
3	8	790581	1/8" Dia SS Rivet
2	0.25	007523	Extreme Adhesive
1	4	7926130	90 Deg. Rail Splice YL UV

PN 505302-DynaRound Safety Gate-30 inch Opening - Light Gray UV

ITEM NO.	QTY REQ'D	PART NUMBER	DESCRIPTION
6 & 7	1	UTILIZE	1.9"Ø Round Tube - LG UV (Parent PN 5001012)
4	1	793115.1	TruClose HD Round Post Hinge (Tru Close PN TCHDRND2-MK2)
3	8	790581	1/8" Dia SS Rivet
2	0.25	007523	Extreme Adhesive
1	4	7926132	90 Deg. Rail Splice LG UV

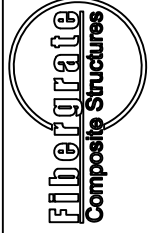

WEIGHT =15.3 lb
(6.9 Kg)

DynaRound

REV	DESCRIPTION	DATE	BY
0	ECN 189	4/25/19	EAL
1	ECN 193	6/21/19	EAL

SCALE N.T.S. DATE: 3/15/19

DRAWN: MFA
SHEET

DRAWING NUMBER
50530X

1 OF 3

DynaRound Safety Gate Kit 30" Opening

PN 505300.1 (UV COATED)-YL

PN 505302.1 (UV COATED)-LG

NOTE: SHIP HINGE INSERTS, HINGE SCREWS, HINGE INSTRUCTIONS AND END SUPPORT COMPONENTS (ALL ITEMS IN DETAIL ON PAGE 3) LOOSE WITH GATE KIT FOR FIELD INSTALLATION.

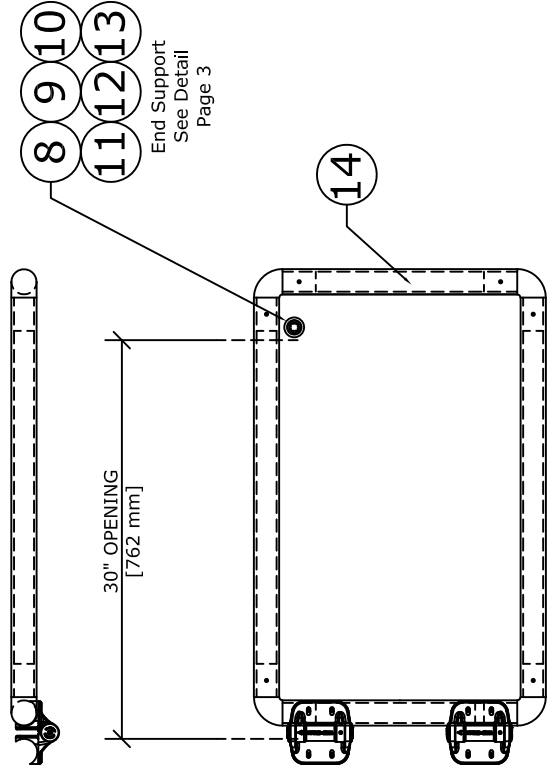

PN 505300.1-DynaRound Safety Gate Kit-30 inch Opening - Yellow UV

ITEM NO.	QTY REQ'D	PART NUMBER	DESCRIPTION
14	1	505240	Dynaround Safety Gate 24" Opening - YL UV
13	1	505100	DynaRound Safety Gate End Support - YL UV
12	1	793115.4	Nut 1/2" Galvanized
11	1	793115.5	Flat Washer 1/2" Galvanized
10	1	793113.1	Caplugs VC-490-8 (Black)
9	1	793115.2	1/2" x 4" Galvanized Carriage Bolt (McM 93604A721)
8	1	793115.3	1/2" x 6" Galvanized Carriage Bolt (McM 93604A729)

REV

0	ECN 189	DATE	BY
1	ECN 193	4/25/19	EAL
		6/21/19	EAL

Fiberglass Composite Structures

WEIGHT =15.8 lb
(7.2 Kg)

PN 505302.1-DynaRound Safety Gate Kit-30 inch Opening - Light Gray UV

ITEM NO.	QTY REQ'D	PART NUMBER	DESCRIPTION
14	1	505242	Dynaround Safety Gate 24" Opening - LG UV
13	1	505102	DynaRound Safety Gate End Support - LG UV
12	1	793115.4	Nut 1/2" Galvanized
11	1	793115.5	Flat Washer 1/2" Galvanized
10	1	793113.1	Caplugs VC-490-8 (Black)
9	1	793115.2	1/2" x 4" Galvanized Carriage Bolt (McM 93604A721)
8	1	793115.3	1/2" x 6" Galvanized Carriage Bolt (McM 93604A729)

DynaRound

SCALE	N.T.S.	DATE	3/15/19
DRAWING NUMBER	50530X		
DRAWN:	MFA	SHEET	2 OF 3

DynaRound Safety Gate 36" Opening

PN 505360 (UV COATED)-YL

PN 505362 (UV COATED)-LG

NOTE: THIS DRAWING IS FOR THE SAFETY GATE ONLY.
SEE PAGES 2 - 3 FOR THE SAFETY GATE KIT.

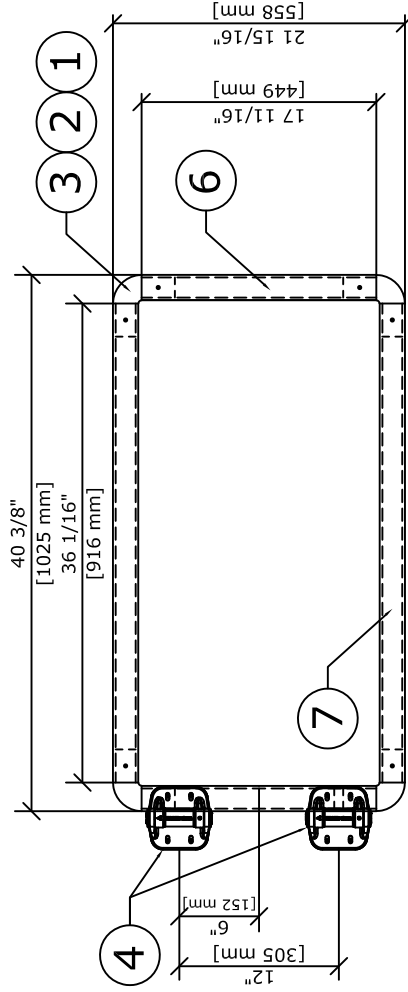

PN 505360-DynaRound Safety Gate-36 inch Opening - Yellow UV

ITEM NO.	QTY REQ'D	PART NUMBER	DESCRIPTION
6 & 7	1	UTILIZE	1.9"Ø Round Tube - YL UV (Parent PN 5001010)
4	1	793115.1	TruClose HD Round Post Hinge (Tru Close PN TCHDRND2-MK2)
3	8	790581	1/8" Dia SS Rivet
2	0.25	007523	Extreme Adhesive
1	4	7926130	90 Deg. Rail Splice YL UV

PN 505362-DynaRound Safety Gate-36 inch Opening - Light Gray UV

ITEM NO.	QTY REQ'D	PART NUMBER	DESCRIPTION
6 & 7	1	UTILIZE	1.9"Ø Round Tube - LG UV (Parent PN 5001012)
4	1	793115.1	TruClose HD Round Post Hinge (Tru Close PN TCHDRND2-MK2)
3	8	790581	1/8" Dia SS Rivet
2	0.25	007523	Extreme Adhesive
1	4	7926132	90 Deg. Rail Splice LG UV

REV	DESCRIPTION	DATE	BY
0	ECN 189	4/25/19	EAL
1	ECN 193	6/21/19	EAL



WEIGHT =16.1 lb
(7.3 Kg)

DynaRound

SCALE	N.T.S.	DATE:
		3/15/19
DRAWING NUMBER		
50536X		

DRAWN:	MFA
SHEET	

DynaRound Safety Gate Kit 36" Opening

PN 505360.1 (UV COATED)-YL

PN 505362.1 (UV COATED)-LG

NOTE: SHIP HINGE INSERTS, HINGE SCREWS, HINGE INSTRUCTIONS AND END SUPPORT COMPONENTS (ALL ITEMS IN DETAIL ON PAGE 3) LOOSE WITH GATE KIT FOR FIELD INSTALLATION.

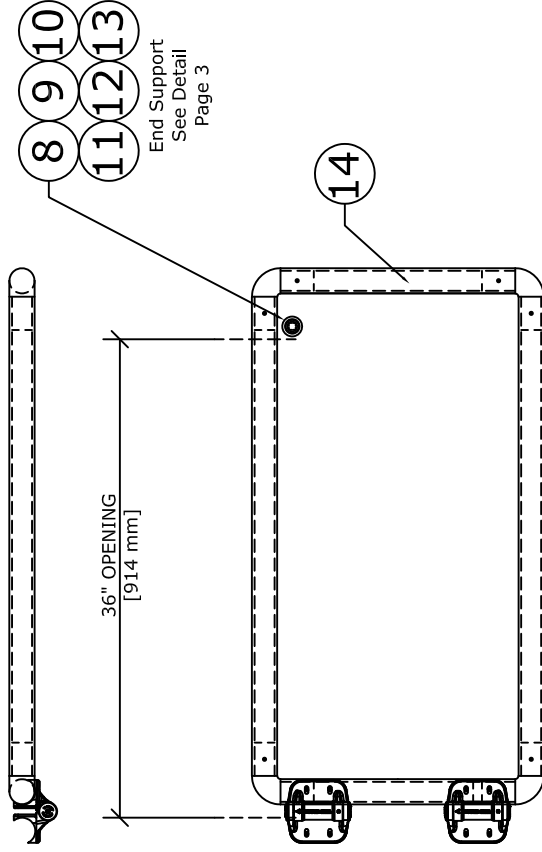

PN 505360.1-DynaRound Safety Gate Kit-36 inch Opening - Yellow UV

ITEM NO.	QTY REQ'D	PART NUMBER	DESCRIPTION
14	1	505240	Dynaround Safety Gate 24" Opening - YL UV
13	1	505100	DynaRound Safety Gate End Support - YL UV
12	1	793115.4	Nut 1/2" Galvanized
11	1	793115.5	Flat Washer 1/2" Galvanized
10	1	793113.1	Caplugs VC-490-8 (Black)
9	1	793115.2	1/2" x 4" Galvanized Carriage Bolt (McM 93604A721)
8	1	793115.3	1/2" x 6" Galvanized Carriage Bolt (McM 93604A729)

PN 505362.1-DynaRound Safety Gate Kit-36 inch Opening - Light Gray UV

ITEM NO.	QTY REQ'D	PART NUMBER	DESCRIPTION
14	1	505242	Dynaround Safety Gate 24" Opening - LG UV
13	1	505102	DynaRound Safety Gate End Support - LG UV
12	1	793115.4	Nut 1/2" Galvanized
11	1	793115.5	Flat Washer 1/2" Galvanized
10	1	793113.1	Caplugs VC-490-8 (Black)
9	1	793115.2	1/2" x 4" Galvanized Carriage Bolt (McM 93604A721)
8	1	793115.3	1/2" x 6" Galvanized Carriage Bolt (McM 93604A729)

REV	DESCRIPTION	DATE	BY
0	ECN 189	4/25/19	EAL
1	ECN 193	6/21/19	EAL

SCALE	N.T.S.	DATE:	3/15/19
DynaRound			
DRAWING NUMBER		50536X	
DRAWN:		MFA	
SHEET		2 OF 3	

WEIGHT =16.6 lb
(7.6 Kg)

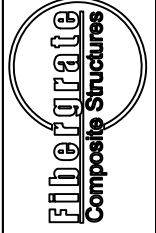

DynaRound Safety Gate Kit 36" Opening

PN 505360.1 (UV COATED)-YL

PN 505362.1 (UV COATED)-LG

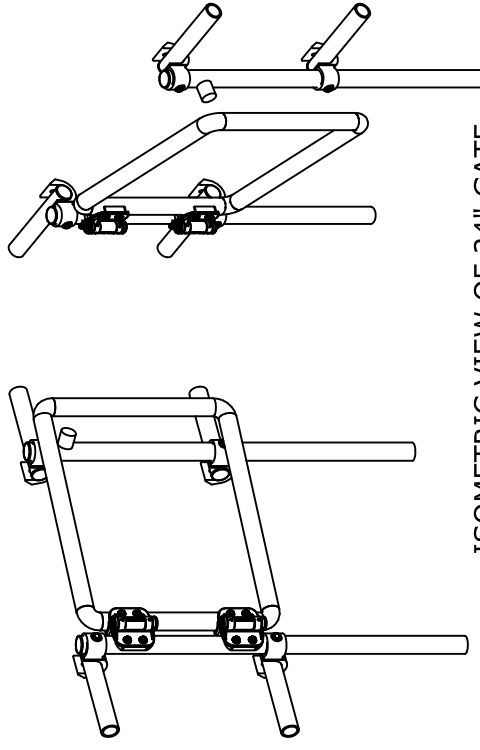
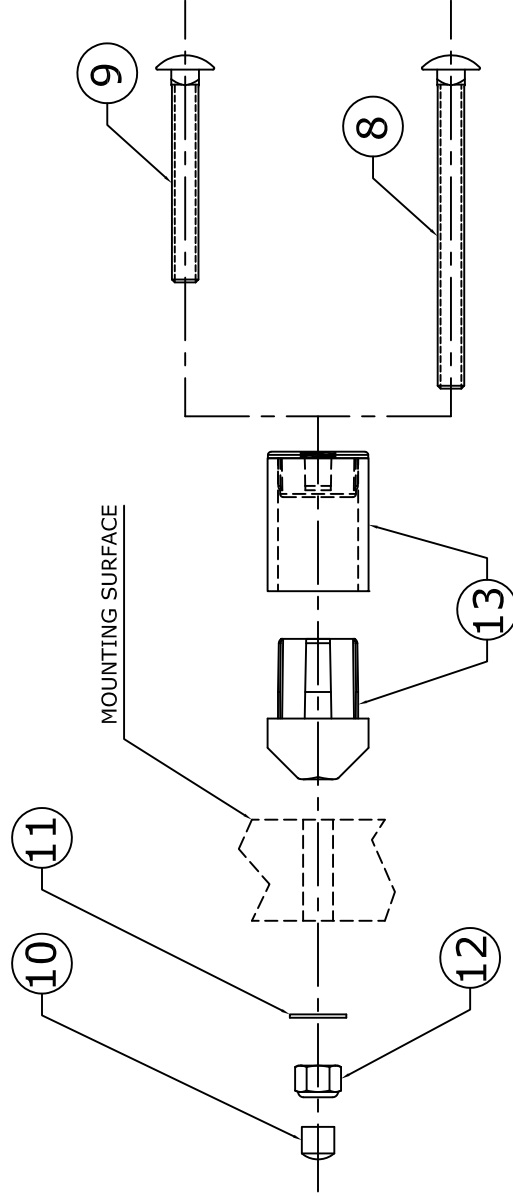

ISOMETRIC VIEW OF 24" GATE
INSTALLED ON DYNAROUND RG
GUARDRAIL

DETAIL OF END SUPPORT - SHIP LOOSE



REV	DESCRIPTION	DATE	BY	DynaRound	
0	ECN 189	4/25/19	EAL	SCALE	N.T.S.
1	ECN 193	6/21/19	EAL	DATE:	3/15/19
				DRAWING NUMBER	50536X
				DRAWN:	MFA
				SHEET	3 OF 3